



OLIMPIC S 1000

Automatic heavy duty single-sided edge bander



OUR TECHNOLOGY BEHIND YOUR IDEAS

olimpic s 1000

Automatic heavy duty single-sided edge bander



EDGE BANDING ON
ALL 4 SIDES

3D DESIGN

PROGRAMMING

CUTTING

EDGE BANDING

3 AXES BORING-ROUTING

CALIBRATING/SANDING

ASSEMBLING

olimpic s 1000

AUTOMATIC HEAVY DUTY EDGE BANDER
The perfect solution for any edge banding
production requirement



S 1000 T-ER4L

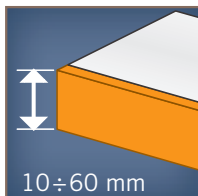
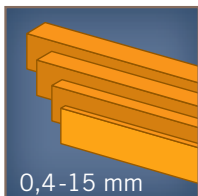



An exclusive level
of technology



Reliability with
high performance



Important
details

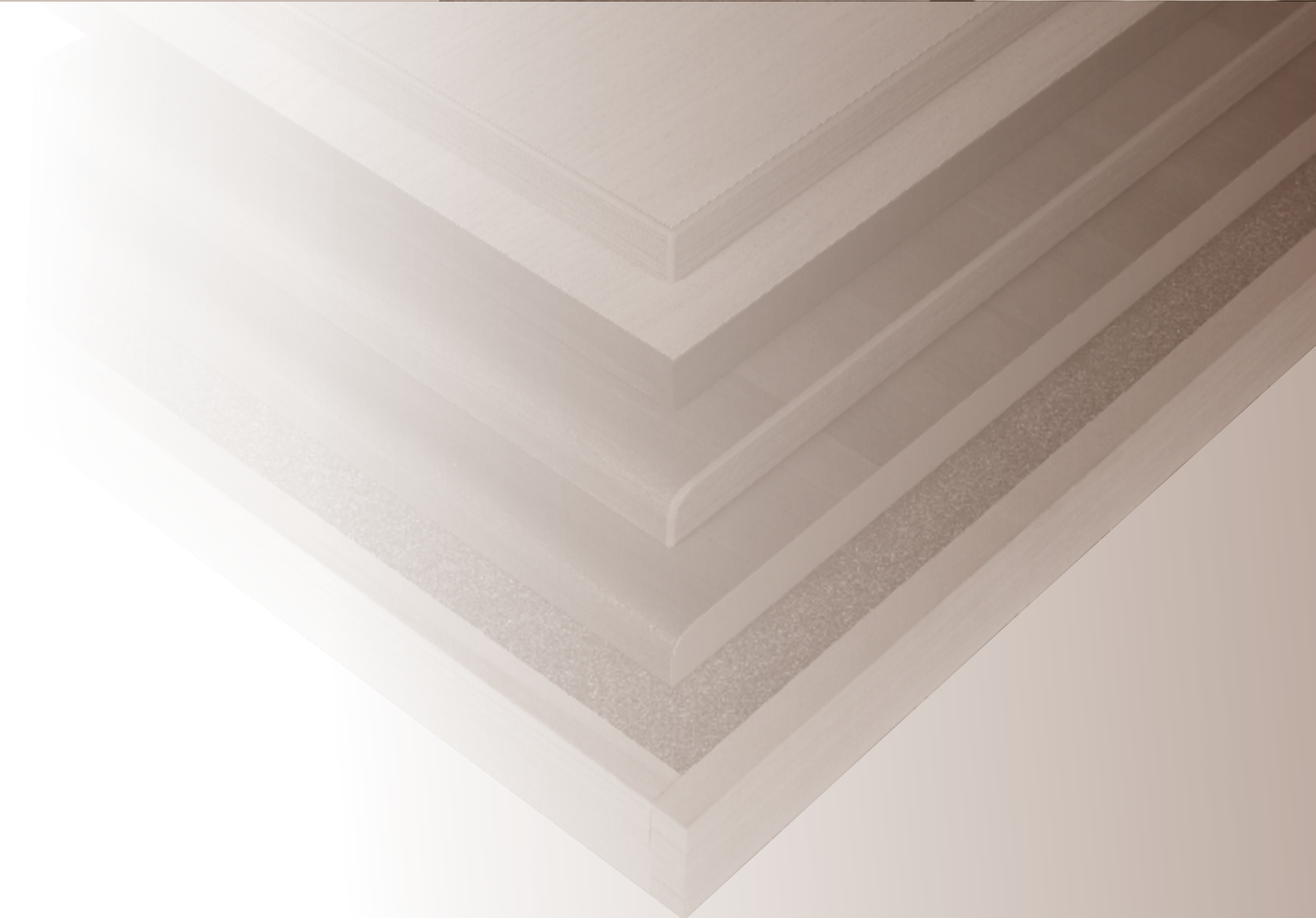
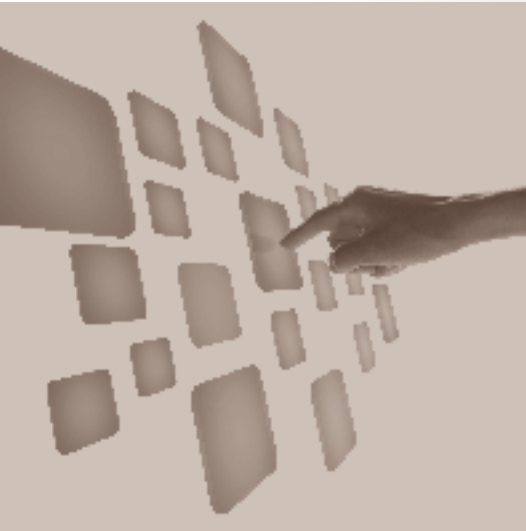



An exclusive level
of technology

INNOVATIVE SOLUTIONS AT THE TOP OF EDGE BANDING SPECIALISATION



BAR CODE READER (OPT)

- ▶ No errors with the automatic program recall



- ▶ Intuitive and easy to use thanks to its customised graphics and one touch mode
- ▶ Large dimensioned display (12")
- ▶ Simple when choosing the machining required
- ▶ "TELESOLVE" (opt) for diagnostic and on line service

STARTOUCH CONTROL (supplied as a standard feature on the entire range)

- ▶ Simple and controlled diagnostics to obtain a quick solution to any malfunctions
- ▶ Indication of the main production data with absolute and partial values
- ▶ Indication for programmed maintenance operations for the machine

CURRENT ALARMS PAGE

ALARM TYPE	DESCRIPTION	STATUS
27	MANCATA RISPONDA IN ALARMI	OK
28	MANCATA RISPOSTA DI RETE	OK
29	PULSANTE SPERIENZA ADONNATO	OK
30	ASSENZA PENSACIA AUTOLANA	OK

PROCESS DATA PAGE

EVENTO	UNITA	VALORE
ONE ACCENSIONE	1	10
FEED LAVORATO	1	1000
MINUC LAVORATO	1	1000
CIRCUITO	1	10

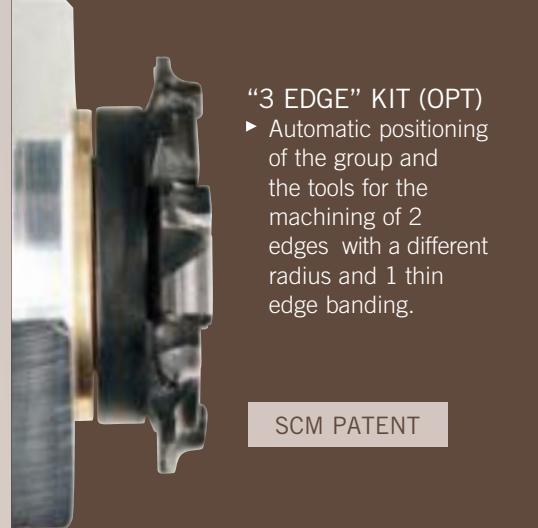

“3 EDGE” KIT (OPT)
 ▶ Automatic positioning of the group and the tools for the machining of 2 edges with a different radius and 1 thin edge banding.

SCM PATENT

ROUND 4M” ROUNDING GROUP

- ▶ Optimum rounding and trimming of the edging up to 5mm for all straight, chamfered and post-formed panels
- ▶ **Particularly suitable for the rounding of solid wood**
- ▶ Rounding angles with 18 m/min track speed
- ▶ ED-SYSTEM high efficiency exhaust hoods

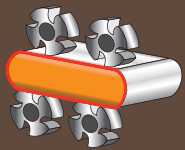
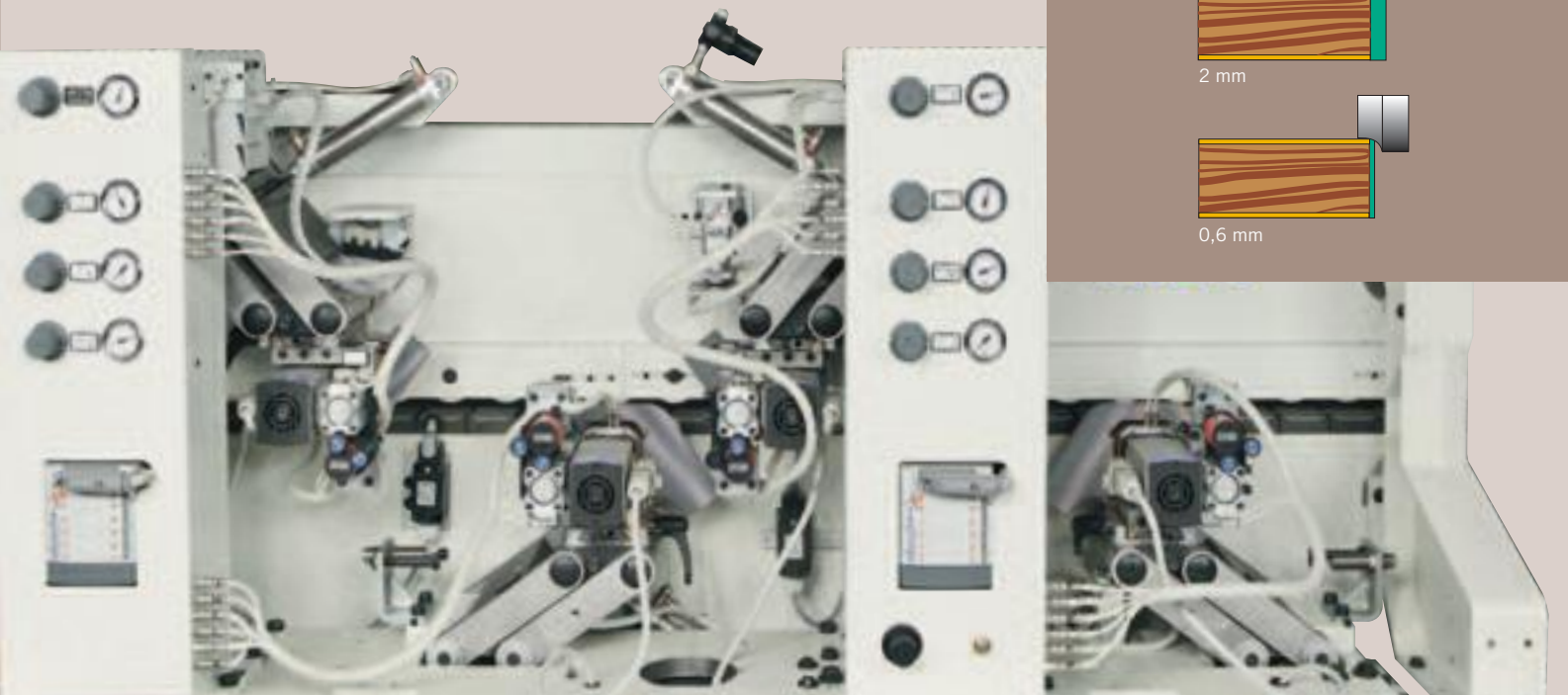
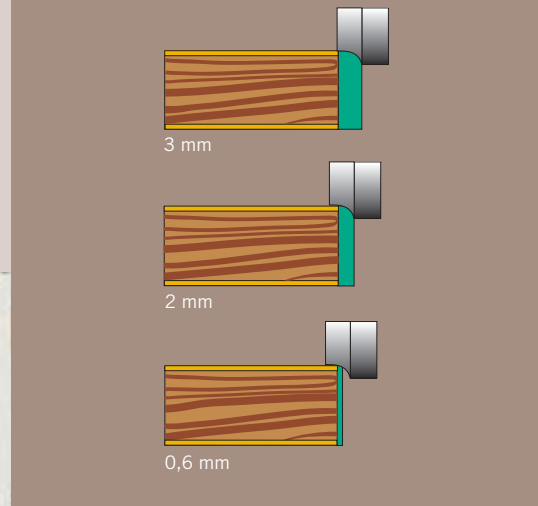

Round 4M rounding group

MACHINING EXAMPLES WITH THE 4 MOTORS ROUND GROUP

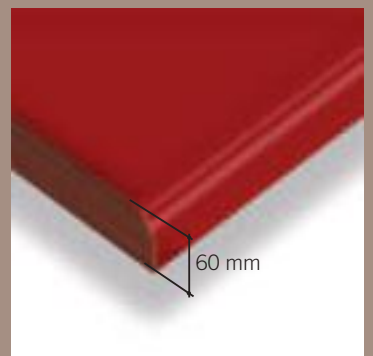
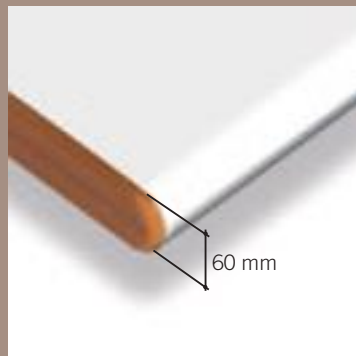
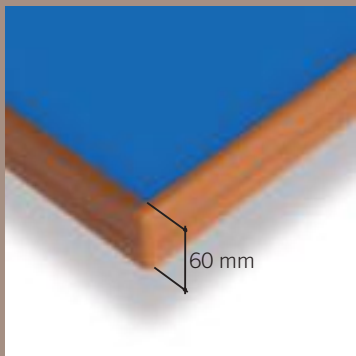



Reliability with high performance

FOR AN INDUSTRIAL PRODUCTION AT THE BEST LEVELS



◀ PANEL SPACER (OPT)

- ▶ Panel introduction into the machine with the correct space between panels
- ▶ **The distance between the panels is automatically optimised according to the selected operating groups**

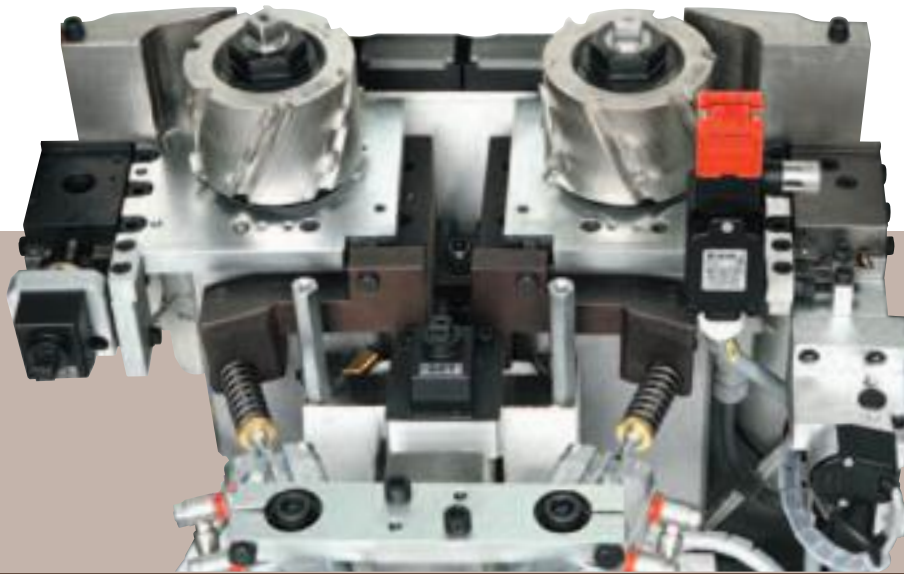

INFRARED CERAMIC LAMP (OPT)

- ▶ Optimum glue adhesion with the cleaning of the machined surface

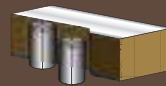
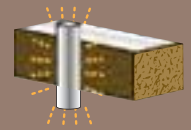

RT-E panel edge trimming group



RT-E PANEL EDGE TRIMMING UNIT

- ▶ Provides a perfect surface for gluing the edge
- ▶ ED-SYSTEM high efficiency exhaust outlets
- ▶ Constant removal on the entire panel length with the copying devices kit supplied as a standard feature



EASY SIZE PLUS" DEVICE (OPT)

- ▶ Allows the adjustment of the material removal of the panel edge trimming group in a few seconds due to the powered axes positioned on the infeed fence and copying device of the group



AAR ANTI-ADHESIVE GROUP (OPT)

- It ensures the highest finish quality by preventing the glue sticking to the upper and lower panel surface

AAR anti-adhesive group

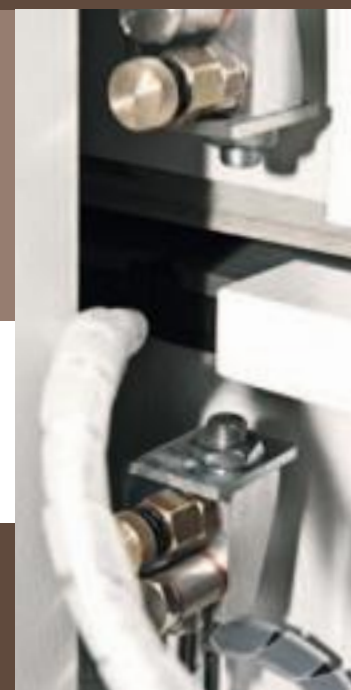
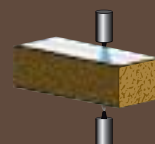



Reliability with high performance

FOR AN INDUSTRIAL PRODUCTION AT THE BEST LEVELS

VC 1000 GLUING GROUP

- ▶ It is possible to edge material strips up to 15 mm thickness and coiled edges up to 3 mm
- ▶ Pre-melting device for the automatic feed of glue to the glue pot (opt), it is advisable for panels which require a high consumption of glue
- ▶ Optimum gluing of solid wood edges with the reverse rotation of the glue roller

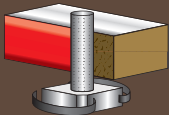
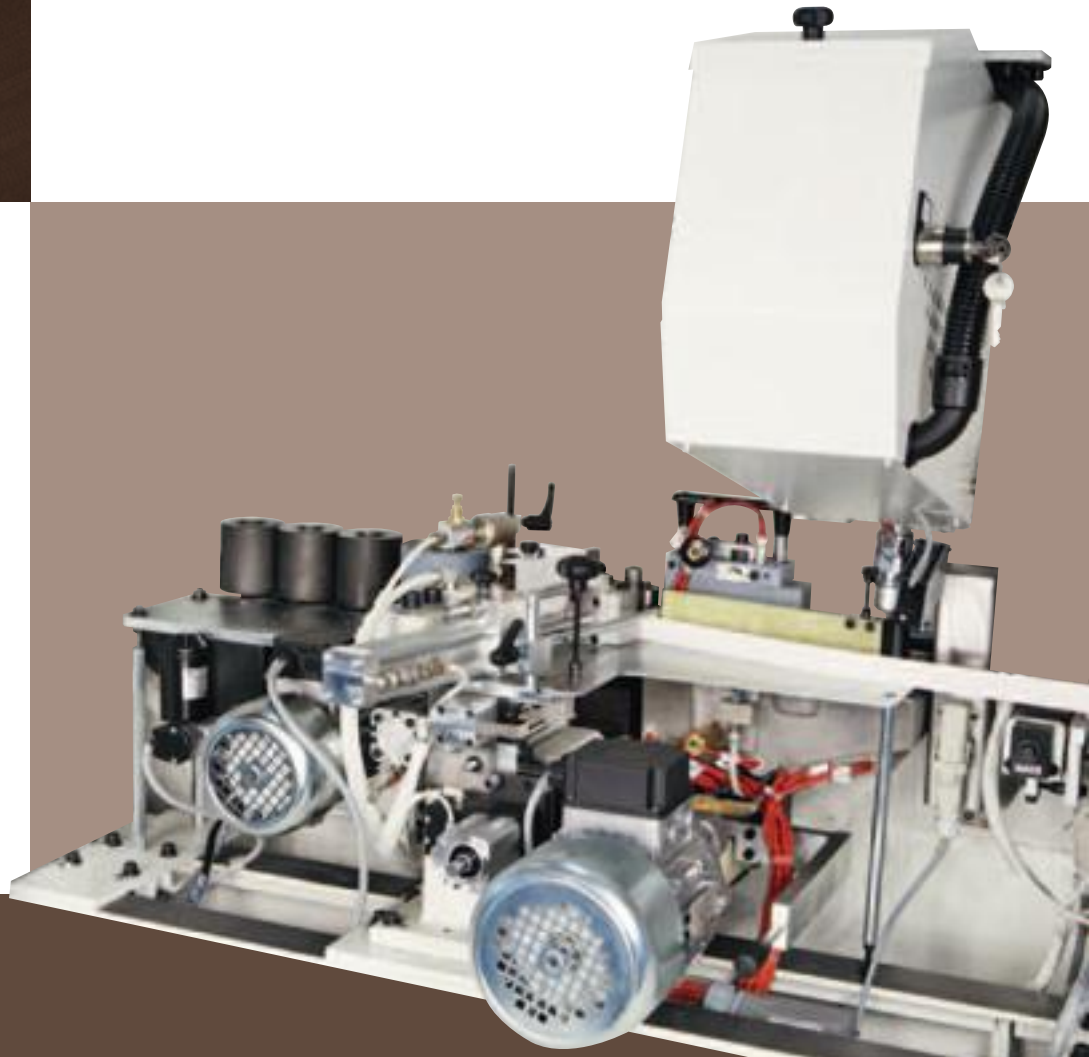

VC 1000 gluing group

LOCKING OF COPYING OPERATION

(supplied as standard feature on the entire range)

- ▶ **Optimum finishing including delicate panels.**
The locking of the glue pot copying operation in the last panel section avoids contact of the roller with the panel.
- ▶ Automatic exclusion of the glue pot in the case of non-use of the group or stopping of the feed track.

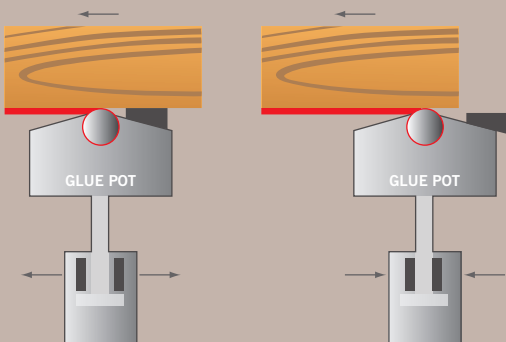

GLUE POT SUBSTITUTION

- ▶ **Rapid changeover of the glue colour/type of glue to be applied**
- ▶ The “Fastlock” rapid unlocking system allows for fast glue pot substitution, while the “double thermoregulation system” (opt) manages two working temperatures in order to apply both EVA and Polyurethane thermosetting adhesives





▶ RSP IN-LINE TRIMMING GROUP

- ▶ For the trimming of a solid wood edging or the removal of the exceeding edge thus providing the following chamfering operation

2 POSITIONS KIT

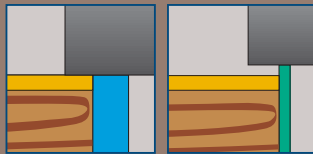

2 ROLLERS DEVICE WITH AUTOMATIC CHANGEOVER (OPT)

- ▶ Automatic edge changeover by means of the 2 clamps device that allows the changeover between the two different edges from the program start pushbutton or the changeover when machining two identical edges.

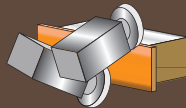
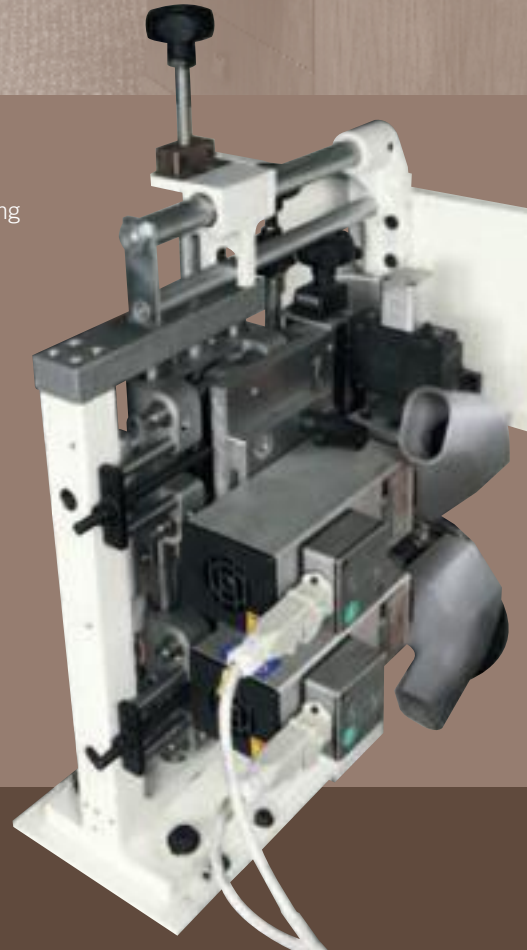

RSP in-line trimming group

K/SEL END CUTTING GROUP

- ▶ The best finishing quality thanks to the motors sliding on two prismatic ball guides.
- ▶ Rapid set-up between straight and angled cutting with the automatic independent lifting of the motors (opt).
- ▶ Horizontal movement of the group in order to leave an exceeding edge that ensures an optimum finish of the Round group (opt).



▲ NESTING COPYING DEVICES (OPT)

- ▶ No difficulty when finishing panels already processed with the "nesting" working cycle, through the suitable copying devices to be mounted on the upper part of the trimming and edge scraping groups



K/SEL end cutting group



Reliability with high performances

FOR AN INDUSTRIAL PRODUCTION AT THE BEST LEVELS

RI/S TRIMMING GROUP

- ▶ The very best finishing quality with the large dimensioned front and vertical rotating copying discs.
- ▶ Rapid machine changeover between thin and radius edges with the 2 positions kit (opt)
- ▶ Solid wood changeover without any operator intervention, thanks to the powered axes
- ▶ ED-SYSTEM high efficiency exhaust hoods

2 POSITIONS KIT

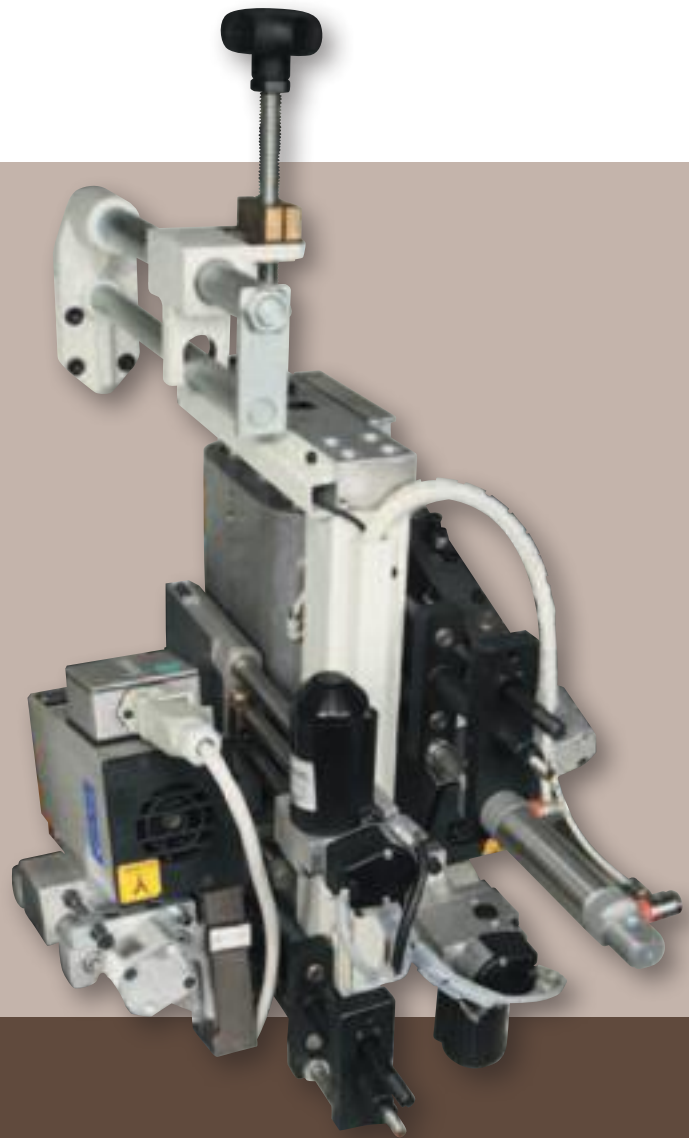
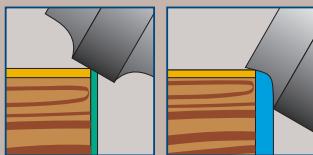

RI/S
trimming group

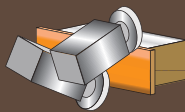

“ED-SYSTEM” EXHAUST SYSTEM

- ▶ Increased cleaning of panels thanks to optimum chips suction with the “ED-SYSTEM” function which couples the encircling exhaust hood to the suitable container with a filter for long chips.

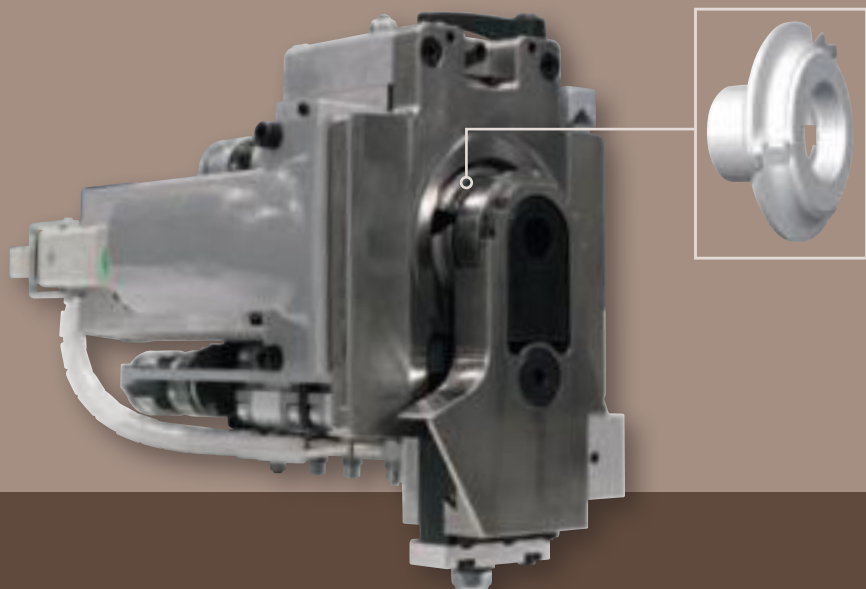



2 MOTORS ROUND GROUP

- ▶ Perfect rounding and trimming of straight, chamfered and post formed panels.
- ▶ **Rounding angles with 18 m/min track speed**
- ▶ ED-SYSTEM high efficiency exhaust hoods

SCM PATENT

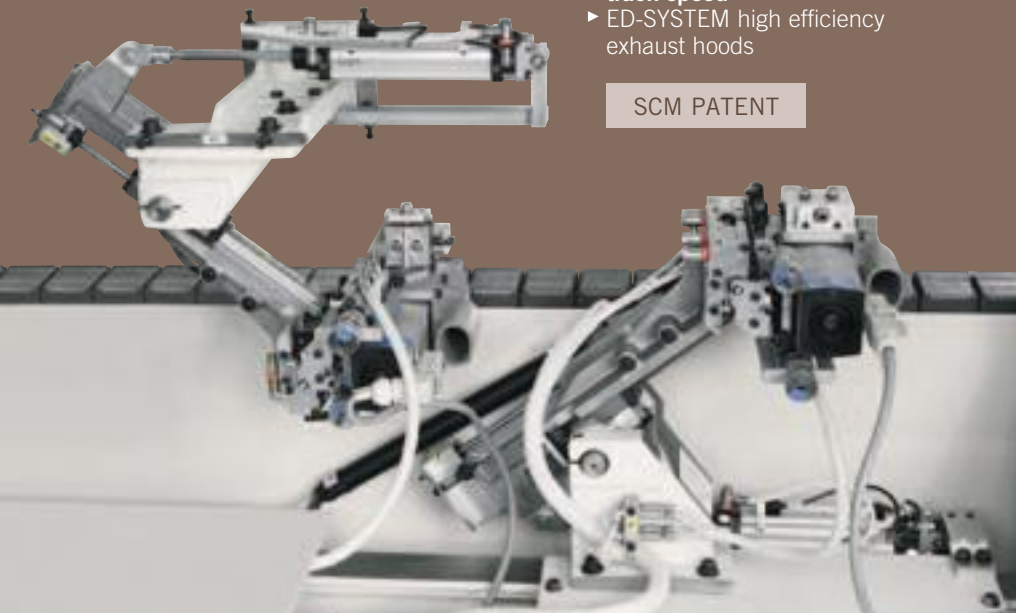

3 mm



0,8 mm

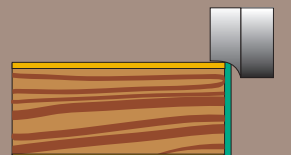

0,6 mm



0,4 mm

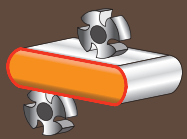

2 motors round group

"4 EDGE" KIT (OPT)

- ▶ Automatic positioning of the group for the machining of 3 thin edges and 1 radius edge

MACHINING EXAMPLES WITH THE 2 MOTORS ROUND GROUP

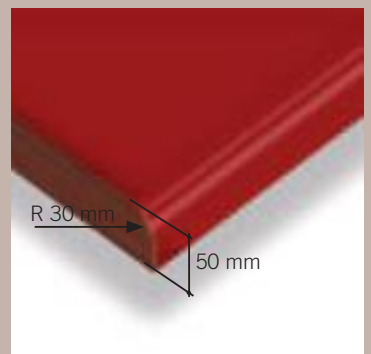
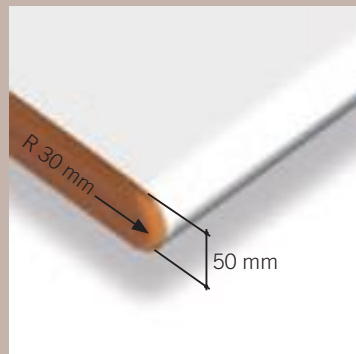
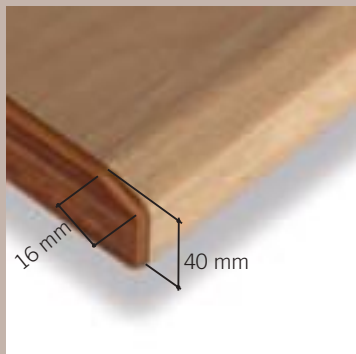
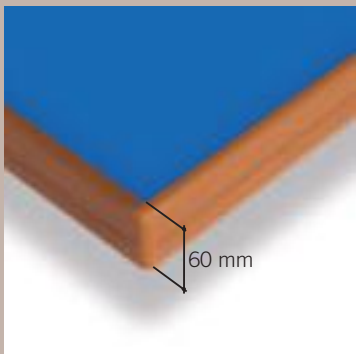



Reliability with high performances

FOR AN INDUSTRIAL PRODUCTION AT THE BEST LEVELS

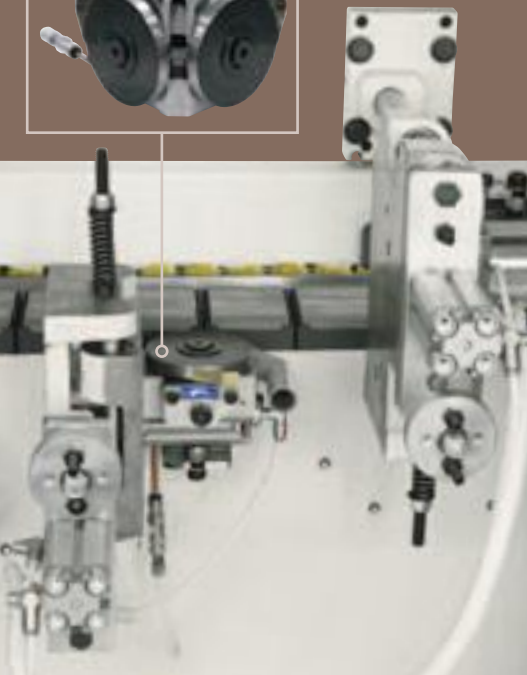

▶ RAS/1000 EDGE SCRAPING GROUP

- ▶ **Rapid and easy work changeover of the radius edge thanks to the substitution of the cutter-head, complete with rotating copying discs.**
- ▶ For the finishing of the PVC/ABS radius edge.
- ▶ The group is complete with extraction hood with suitable container with filter for long chips.

▶ RAS/S 2P EDGE SCRAPING GROUP (OPT)

- ▶ **Automatic work changeover of the radius edge through the two tool pneumatic positions.**
- ▶ For the finishing of the PVC/ABS radius edge
- ▶ The group is complete with large dimensioned extraction hood with suitable container with filter for long chips.

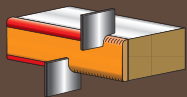

RAS/1000 edge scraping group

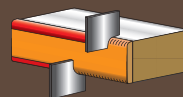

RAS/S 2P edge scraping group

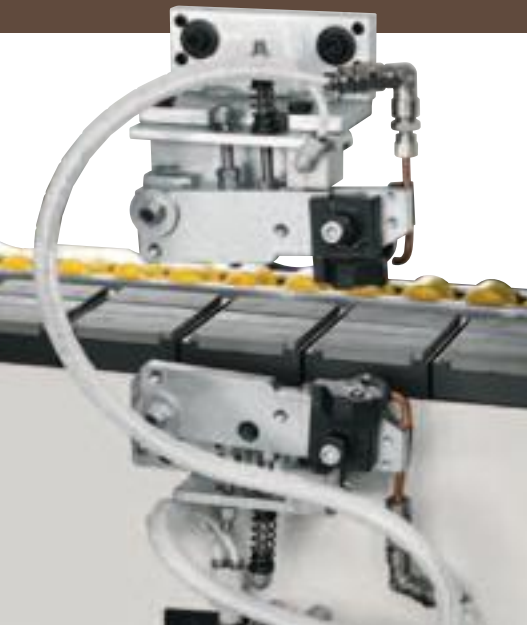

▶ RCL GLUE SCRAPING GROUP (OPT)

- ▶ Eliminates any excess glue on the panel surface.
- ▶ Optimum use with soft/ post formed panels thanks to the independent intervention of the two tools.

▶ RCA/2C GLUE SCRAPING GROUP (OPT)

- ▶ Eliminates any excess glue on the panel surface.
- ▶ Best finishing quality even on the panel edges due to the two rotating copying discs

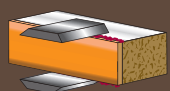

RCL glue scraping group

RCA/2C glue scraping group

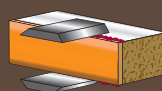

▶ T-1000 SPINDLE MOULDER GROUP (OPT)

- ▶ It machines through grooves or stopped grooves on the lower, upper and front panel surfaces.
- ▶ Equipped with a powerful motor (4kW) and reverse rotation of the tool.
- ▶ The group is complete with front and vertical copying devices and exhaust hood.

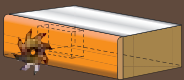
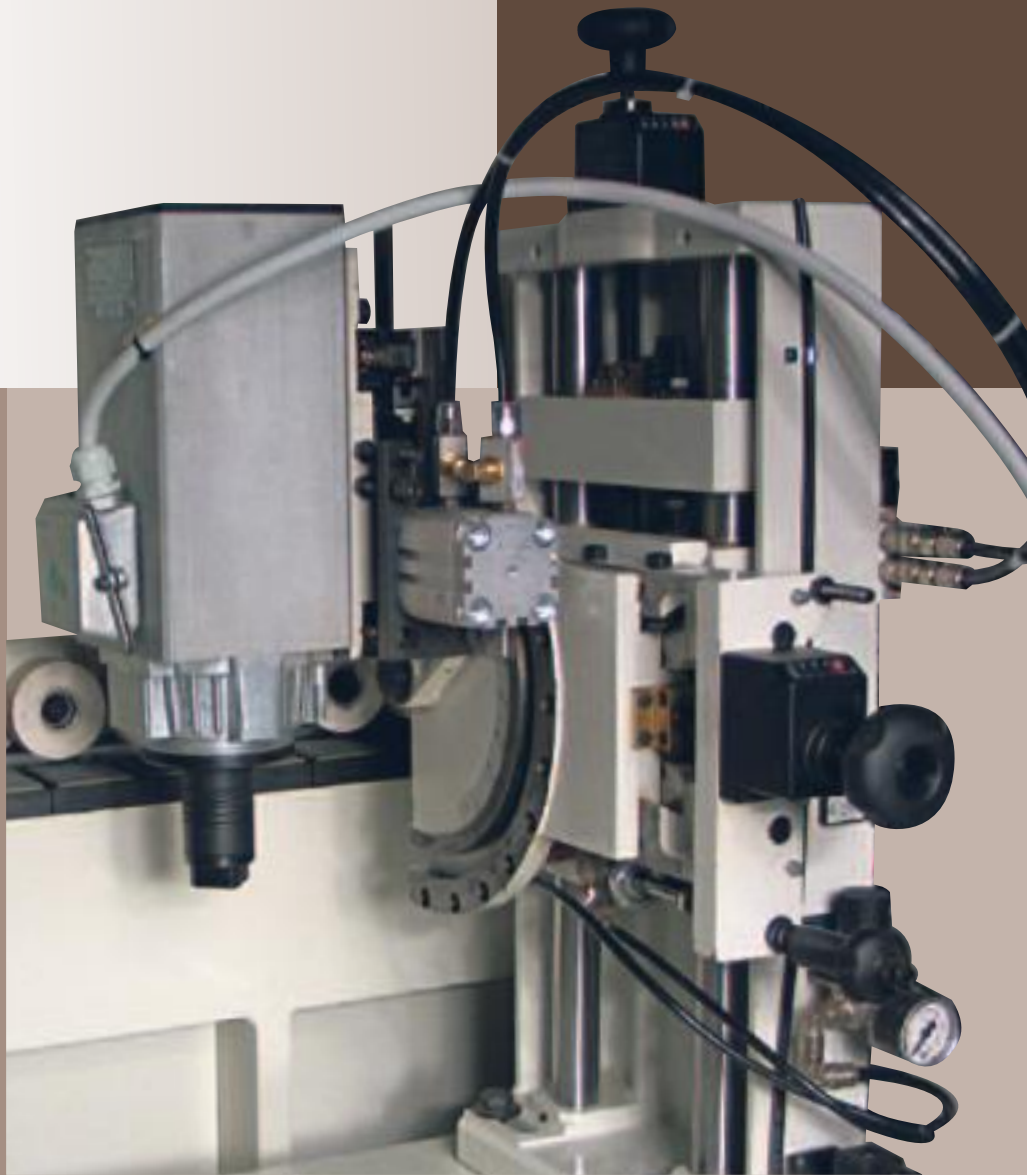

T-1000 spindle moulder group

▶ GLC SANDING GROUP (OPT)

- ▶ For the sanding of the flat surface on the front panel edge
- ▶ Optimum sanding with the adjustable contact pressure of the pad and the oscillating abrasive belt
- ▶ Timed intervention sanding to prevent damage to the front and end panel edges.

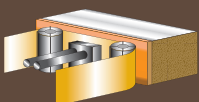
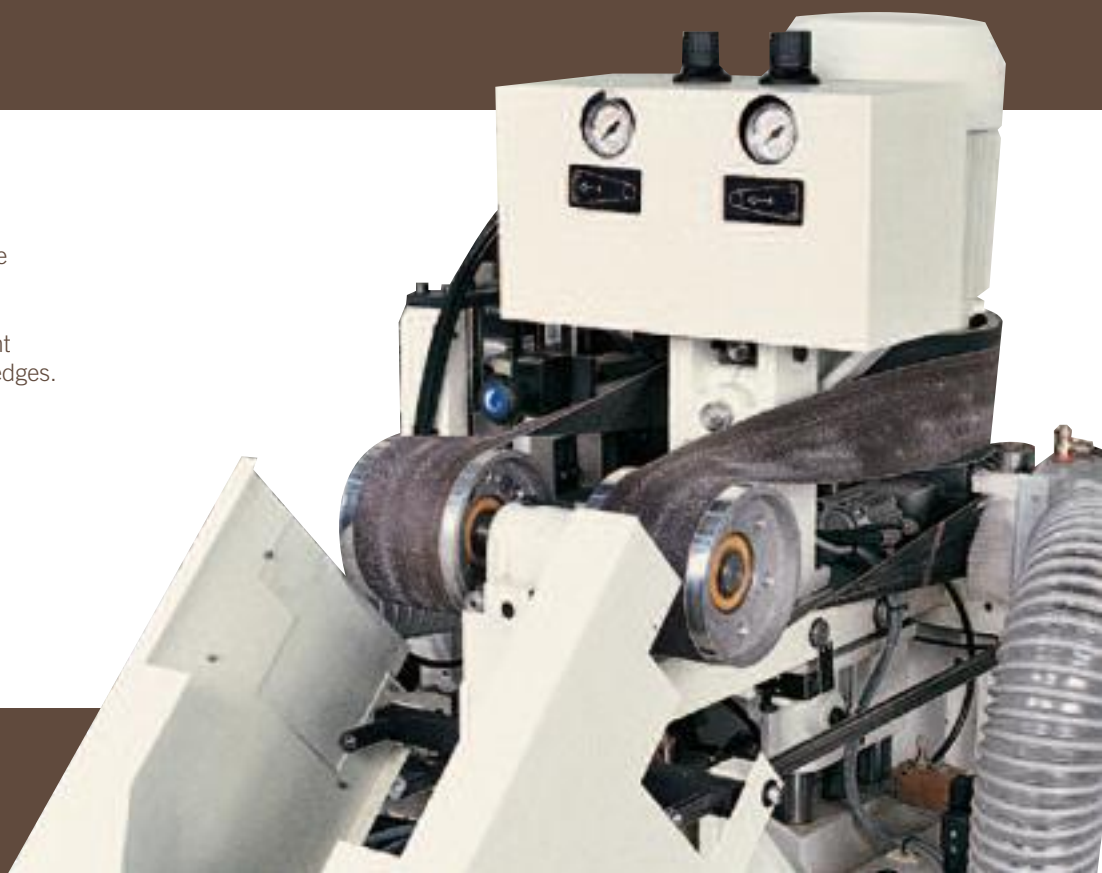

GLC sanding group



Reliability with high performances

FOR AN INDUSTRIAL PRODUCTION AT THE BEST LEVELS



- ◀ **SPN BRUSHING GROUP**
 - ▶ Allows panel cleaning and polishing
 - ▶ Easy adjustment with the hand wheel supplied with the group

SPRAY-MIST DEVICE FOR EDGE FINISHING (OPT)

- ▶ It improves the panel cleaning and the polishing of the PVC/ABS edge.

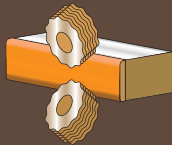

SPN brushing group

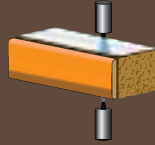

Spray-mist device

- ▶ **HOT AIR BLOWER FOR PVC/ABS EDGES (OPT)**

- ▶ It reactivates the colour of the PVC/ABS edges

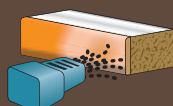

Hot air blower



Important details



◀ EDGE DETECTION SYSTEM (OPT)

- ▶ It controls the correct loading of the edging thus avoiding the production of non-edged panels and the residual glue left on the machine



▶ PANEL MOVEMENT SYSTEM

- ▶ **Perfect straight movement of the chain and panel holding due to the large dimensioned chain (1-1/4")**
- ▶ Automatic lubrication of the blocks

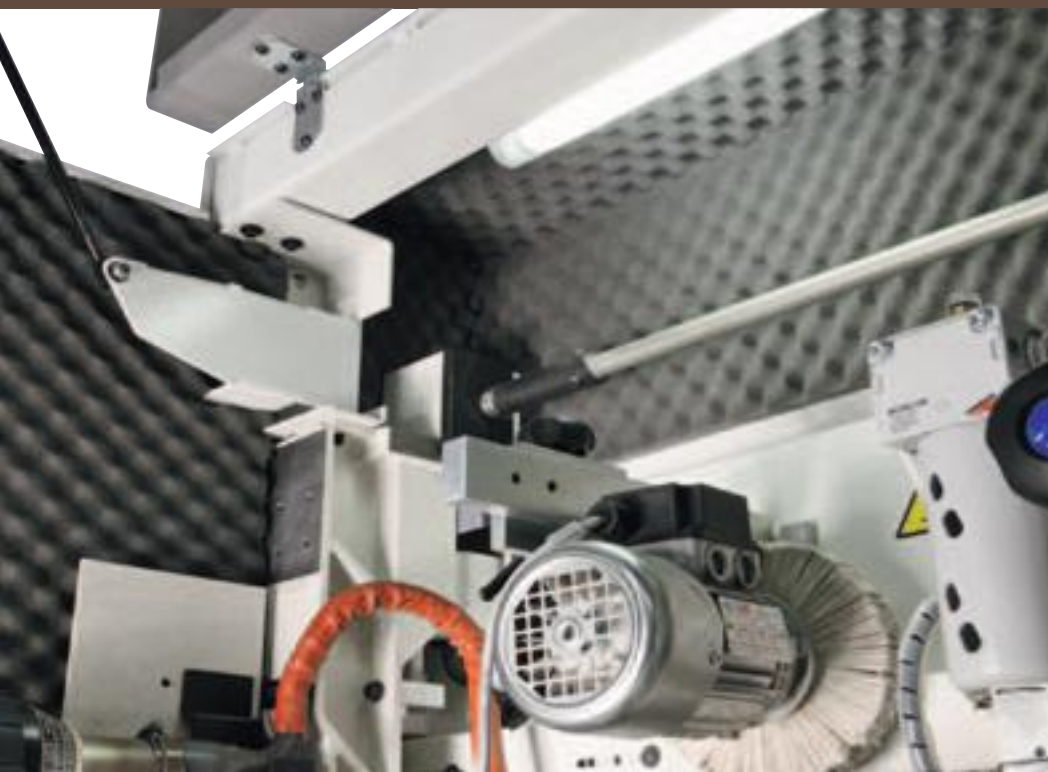

▶ SAFETY ENCLOSURE LINED WITH SOUNDPROOF MATERIAL

- ▶ For better adjustment of the groups and controls when machining, it is complete with lamps for internal lighting as a standard feature.
- ▶ For a lower noise level it is internally coated with a soundproof material

NETLINE

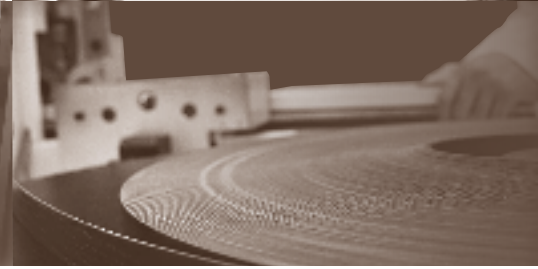
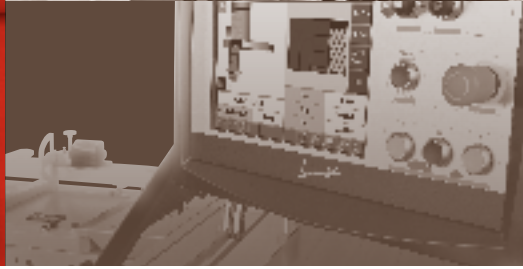

PREPARATION

INTERIOR DESIGN

3D DESIGN

- ▶ **xcab**

3D project of a sequence of cabinets_Definition of the cutting list to be optimised_Boring routing program generation_Extremely easy to use
- ▶ **giotto**

3D project of a complete room furniture (including under roof)_ Rendering _Direct export of the cutting list to be optimised/sized_ Boring routing program generation and hardware management_ Preinstalled, customisable and parametric furniture database
- ▶ **imos**

3D project of a complete room furniture_ Rendering _Direct export of the cutting list to be optimised/sized_ Boring routing program generation and hardware management _Automatic generation of product catalogue_Integrable with company management IT system

PROGRAMMING

- ▶ **ultracut**

Panel optimisation_Cutting guide (navigator) for L'invincibile saw
- ▶ **ottimo**

Multi-job optimisation_Costs and times definition_ Material stock management
- ▶ **xylog plus**

Boring and routing schemes programming _Machine functions and barcode management_Shared by all SCM CNC machines
- ▶ **flashnest**

Nesting optimisation_Easy to learn and to use

PROCESS COMPLETION

3 AXIS CNC BORING ROUTING

- ▶ **cyflex**

All boring operations and grooving_Safety enclosure on working unit instead of floor mats_Dust extraction on the base_CNC SCM / Xilog Plus on PC Office
- ▶ **tech**

All boring operations and grooving, Outside profiling and routing_Horizontal group and HSK 63F 11kW (S6) SCM electrospindle with Vector axis_CNC SCM / Xilog Plus on PC Office_Protection Bumpers to optimize alternate work process (no safety mats required)
- ▶ **pratix**

Nesting processing_Vertical boring operation_Outside profiling and routing

CURVED EDGING

- ▶ **olimpic m**

Curved and Straight Panels_Thickness up to 3 mm_Edge height up to 80 mm



OPTIMISE TIME AND RESOURCES!
 SELECT THE SOFTWARE AND SCM
 MACHINES MEETING YOUR INVESTMENT
 AND PRODUCTION CAPACITY AND YOU'LL
 HAVE ALL THE ADVANTAGES OF THE
INTEGRATED PROCESS.

INTEGRATED PRODUCTION

CUTTING

▶ **seghe circolari**

Invincibile

Post-forming, parallel cutting, angular cutting by means of FULL SUPPORT_Touch screen control and operator's assistance with graphic help_Wireless data transmission between digital readouts of squaring rule stops and full support

▶ **sigma**

Grooves execution, slots execution device, postforming_Saw carriage up to 135m/min and pusher up to 70 m/min_Automatic detecting system for length, width and panel thickness_Automatic blades locking with selector

▶ **pratix**

Nesting processing_Vertical boring operation_Outside profiling and routing

STRAIGHT EDGING

▶ **olimpic k**

Solid wood up to 12 mm, thin edges and ABS up to R 3 mm_Soft/postformed panels_“StarTouch” control system with 12” touch screen display_Pur glue applicable

▶ **olimpic s**

Solid wood up to 22 mm, thin edges and ABS up to R 3 mm_Soft/postformed panels_Winedge PC control system_Pur glue applicable

CALIBRATING SANDING

▶ **sandya**

Solid wood calibrating, sanding and finishing_Calibrating of chipboard, m.d.f. and other wooden panels_Veneered panels presanding, sanding and finishing_Logic touch screen electronic programmer for the total machine control

ASSEMBLING

▶ **assembla e-p**

Manual loading for small lots and customised furniture manufacturing_Open rear structure, with unloading support roller and photocells safety bar_Manual or automatic movements, controlled from 3,8”touch screen

INTEGRATED PROCESS

olimpic s 1000

TECHNICAL DATA

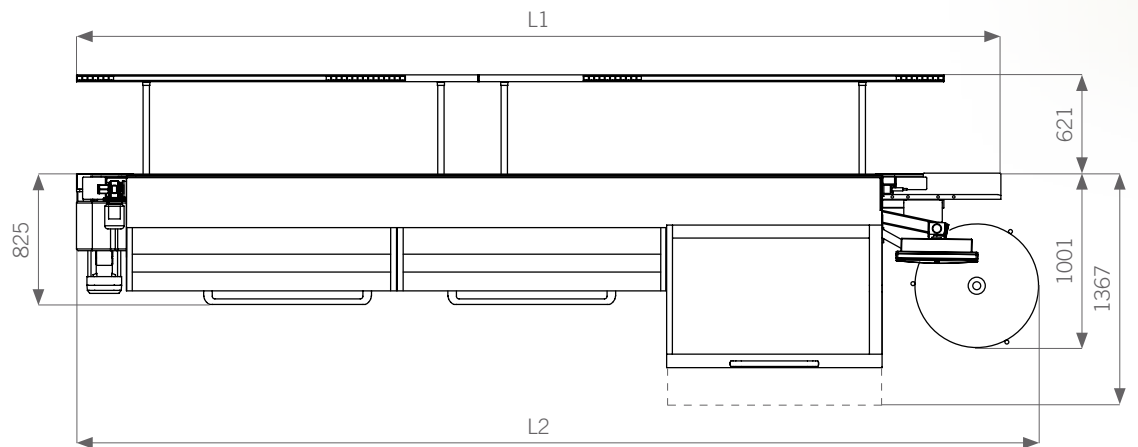

MACHINE LENGTH

Composition		T-EL	T-ERL	T-ERS	T-ER4L
Length - L1	mm	5435	6435	6835	6835
Length - L2	mm	5673	6673	7073	7073

TECHNICAL DATA

Panel thickness	mm	10 - 60
Edge thickness	mm	0,4 - 15
Min. panels length	mm	140
Feed speed	m/min	12 / 18 (10 - 22)

NOISE LEVEL

Operating conditions: PANEL EDGE BANDING (reference standard EN 1218-4:2004+A2:2009)*

	Operator position	Reference standard	Uncertainty factor K (prob. 68.27%)	EDGE BANDING	
				VSA	LAV
Lop: noise level at operator position - dB (A) and peak level - [dB (C)]	Input	UNI EN ISO 11202-97	≤ 4 [dB(A)]	76.0	78.7 [104.4]
	Output			76.3	80.3 [108.4]
	Lw: emitted noise level - dB (A)re 1pW - [mW (A)]		ISO 3746-95	≤ 4 [dB (A)]	94.0 [2.5]

The maximum instantaneous noise level pressure C, is under 130 dB (C)

VSA: no machining without dust extractor equipment LAV: machining

* See the test report for an analysis of the different operating conditions used in compliance with the norms mentioned above

AVAILABLE SOLUTIONS



THE OPTIONAL GROUPS

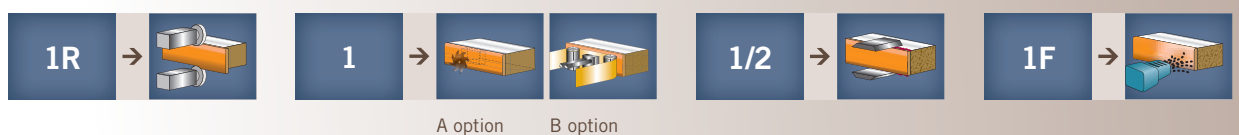





















SIN&T



The technical data can vary according to the requested machine composition. In this catalogue, machines are shown with options. The company reserves the right to modify technical specifications without prior notice; the modifications do not influence the safety foreseen by the CE Norms.

 **scm**
 **minimax**
 **scm tecmatic**

 **scm**
 **routech**
 **celaschi**
 **dmc**
 **superfici**
 **sergiani**
 **gabbiani**
 **morbidelli**
 **mahros**
 **stefani**
 **cpc**
 **sag**
 **scmgroup**
 **delmac**
 **scmfonderie**
 **steelmec**
 **hiteco**
 **es**
 **csr**
 **CMS Cms**
wood technology
 **CMS Cms**
advanced materials technology
 **CMS Brembana**
stone technology
 **CMS Brembana**
glass technology
 **CMS CmsPlast**
plastic technology
 **CMS Tecnocut**
waterjet technology
 **CMS Balestrini**

1 large integrated group
18 production sites
30 specialist brands
21 foreign branches
more than 50 years in business
70% exports
350 agents and distributors
365 registered patents
500 engineers
3.000 square metres showroom
10.000 classical and professional
machines made per year
240.000 square metres
of production space



passion**technology**performance
www.scmgroup.com

scm  **group**



The best global partner that is very close to woodworking companies





Rev. n. 01 - 09/2012 - Acambi comunicazione - Ad_LifeinPixel